

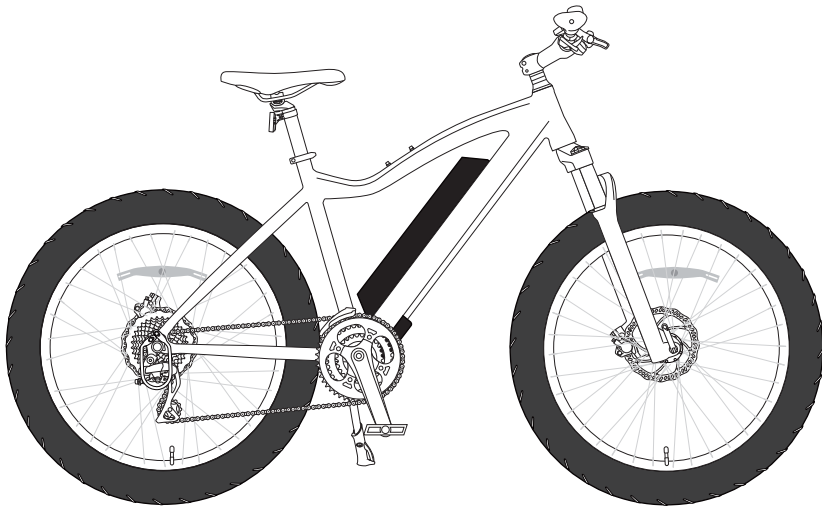

# ***NCM ASPEN+ 48V***

## **OWNER'S MANUAL**

---



Important information enclosed: please read before your first ride!  
Please keep the manual for future use!

---

<b>1. GENERAL INTRODUCTION</b>	
1.1 Welcome .....	01
1.2 Use of the Manual .....	01
1.3 Service and Technical Support .....	01
1.4 Choosing the Right Size .....	01
1.5 Bike Components .....	02
1.6 Range .....	03
1.7 Shifting Recommendations .....	03
<b>2. SAFETY</b>	
2.1 Battery & Charger .....	04
2.2 Bike Usage .....	04
2.3 Transport .....	07
2.4 Keys .....	07
2.5 Liability Disclaimer .....	07
<b>3. INSTALLATION AND ADJUSTMENT</b>	
3.1 General remarks .....	08
3.2 Handlebar and Stem Assembly .....	08
3.3 Assembly of the Pedals .....	09
3.4 Seat Position .....	10
3.5 Saddle Height .....	11
3.6 Saddle Adjustment .....	11
3.7 Locking the Suspension Fork .....	11
3.8 Brakes .....	12
3.9 Shifter and Derailleur Adjustment .....	13
<b>4. E-PARTS OVERVIEW</b>	
4.1 Explanation .....	14
4.2 Battery & Charger .....	14
4.2.1 Overview .....	14
4.2.2 General Remarks .....	15
4.2.3 Installing and Removing the Battery .....	15
4.2.4 Charging .....	15
4.2.5 Usage .....	16
4.2.6 Storage .....	16
<b>5. DISPLAY</b> .....	17
<b>6. RECOMMENDATIONS AND MAINTENANCE</b>	
6.1 General Requirements .....	25
6.2 Maintenance Schedule .....	25
6.3 Troubleshooting .....	27
6.4 Definition of Tampering and Recommendations .....	28
<b>7. TECHNICAL DATA</b> .....	29
<b>8. WARRANTY</b> .....	29

---

# 1. GENERAL

## 1.1 Welcome

We would like to thank you for your purchase of an NCM E-bicycle and welcome you to our fast-growing family of E-bike enthusiasts. Bicycles offer unparalleled practicality and excitement, and our E-bikes at NCM are supercharged versions of this amazing invention. As bikes have evolved so have we, standing at the forefront of innovation in E-cycling technology, aiming to offer something new and thrilling while keeping and promoting the soul of cycling.

## 1.2 Use of the Manual

We encourage you to read this manual thoroughly before you take your new NCM E-bike for a ride. It is important not to overlook the safety instructions and explanations of both traditional and non-traditional bike parts, as this will offer you a general understanding of your new NCM E-bike. This manual is designed to help you get the most out of your E-bike, and so we have attempted to answer as many of your potential questions as possible. Please take a moment to read through the various sections before you get in the saddle.

## 1.3 Service and Technical Support

This manual is intended as a general overview of your new NCM E-bike, and is therefore not an extensive reference. For technical support, including information about service, maintenance and repairs, please consult your dealer. You can visit our website ([www.ncmbikes.com](http://www.ncmbikes.com)) for more information about our products and technology, or to find a dealer close to you. You can also email us your inquiries at [support.au@ncmbikes.com](mailto:support.au@ncmbikes.com), [support.uk@ncmbikes.com](mailto:support.uk@ncmbikes.com), [support.nz@ncmbikes.com](mailto:support.nz@ncmbikes.com).

## 1.4 Choosing the Right Size

An important consideration when selecting the size of your new bike is the stand-over clearance: the distance between you and the top tube of the bike when you stand over it with your feet flat on the ground. For most bicycles, this distance should be at least 1" (25 mm). If you are choosing a mountain bike, it is recommended to have at least 2" (50 mm) of space. Your bike dealer can assist you in finding a bicycle with the correct dimensions for you.

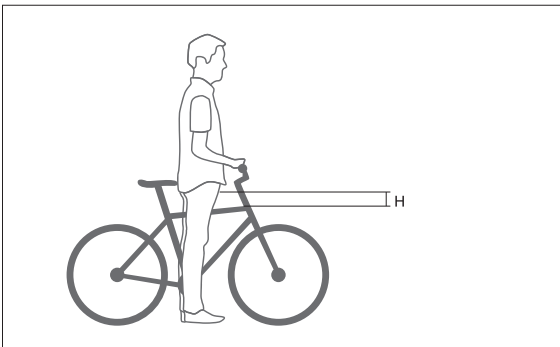

Figure 1

H = stand-over clearance

Minimum: 1" for most bicycle types

2" for mountain bicycles

For some bicycles, like low-step cruisers, stand-over clearance measurement cannot be used as they either do not have a top tube or it is sloped very low. For these bikes the height of the seat post should be used to select the correct size. You should be able to touch the ground comfortably while sitting in the saddle when it is at its lowest point in the seat tube. Adjusting the saddle can further improve the comfort, fit and performance of your bike.

The valid total weight of the electric bike states the load of the bike itself and the driver. Certain parts have their own load limits, such as the rear carrier; please consult your dealer if you are unsure of the load limits of your bike's parts.

## 1.5 Bike Components

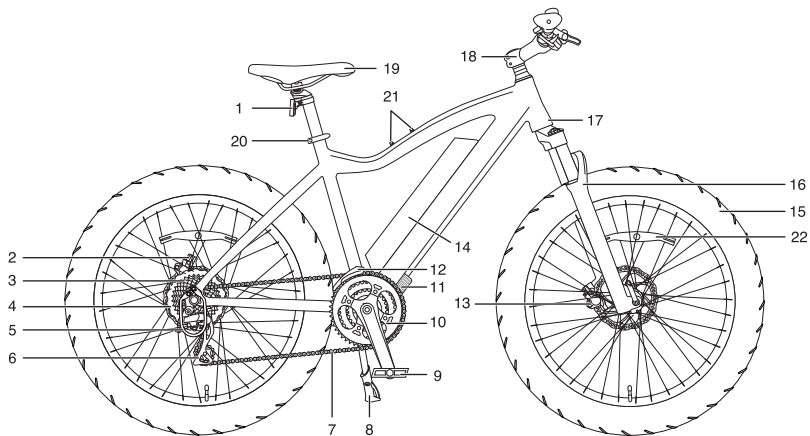

- |                              |                                    |
|------------------------------|------------------------------------|
| 1. Rear Reflector            | 13. Front Disc Brake               |
| 2. Rear Disc Brake           | 14. Battery                        |
| 3. Freewheel                 | 15. Tyre                           |
| 4. Motor                     | 16. Front Fork                     |
| 5. Rear Derailleur Protector | 17. Frame Number                   |
| 6. Rear Derailleur           | 18. Stem                           |
| 7. Chain                     | 19. Saddle                         |
| 8. Kickstand                 | 20. Saddle Quick Release           |
| 9. Pedal                     | 21. Water Bottle Bolt              |
| 10. Crankset                 | 22. Wheel Reflector                |
| 11. Controller               | (reflectors may differ by country) |
| 12. Front Derailleur         |                                    |

**Handlebar Attachments**

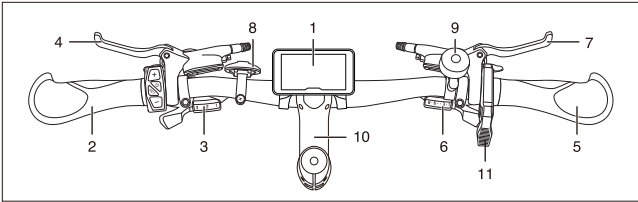

- |                          |                              |
|--------------------------|------------------------------|
| 1. Display               | 7. Right E-brake Lever       |
| 2. Left Grip             | 8. Front Reflector           |
| 3. 3-speed Front Shifter | 9. Bell                      |
| 4. Left E-brake Lever    | 10. Stem                     |
| 5. Right Grip            | 11. Throttle (for NZ market) |
| 6. 8-speed Rear Shifter  |                              |

**Frame Number**

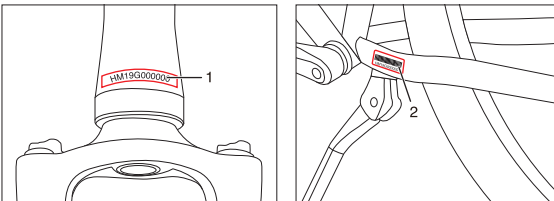

1. Frame Number (head tube)
2. Frame Number (sticker)

**1.6 Range**

The range on one battery charge strongly depends on several conditions, such as (but not limited to):

- Road conditions, such as road surface and slope.
- Weather conditions, such as temperature and wind.
- Bike conditions, such as tyre pressure and maintenance level.
- Bike usage, such as acceleration, shifting, and motor assistance level.
- Weight of rider and cargo.
- Number of charge and discharge cycles.

**1.7 Shifting Recommendations**

For improved range, we advise shifting according to speed. For setting off and traveling at low speeds, a lower gear is best. At higher speeds a higher gear should be chosen. Releasing pressure from the pedals while shifting will allow for smooth support and improved range.

- High speed, high gear
- Low speed, low gear
- Reduce pedal pressure when shifting

## 2. SAFETY

### 2.1 Battery & Charger

- Keep the battery and charger away from water and heat sources.
- Do not connect positive and negative terminals.
- Keep the battery away from children and pets.
- Use the battery and charger only for their intended purpose as part of your E-bike.
- Do not cover the battery and charger, place objects on top of it or rest objects against it.
- Do not subject the battery and charger to shocks (e.g. by dropping).
- Stop the charging procedure immediately if you notice anything unusual.

In the unlikely event of the battery catching fire, DO NOT attempt to put it out with water. Use sand or another fire retardant instead and call emergency services immediately.

Avoid contact with the battery and charger during the charging procedure; the charger heats up considerably.

 Please take note of the additional information on the rear of the battery case.

### 2.2 Bike Usage

Try all settings on the E-bike and become accustomed to their various results in a safe and controlled environment before you try riding the bike on the open road. Bicycles with pedaling support may handle somewhat differently depending on the settings being used.

## IMPORTANT SAFETY INFORMATION

1. Always wear a helmet while riding. Make sure your helmet complies with local laws.
2. Keep body parts and other objects away from moving bicycle parts which may cause you harm, such as the wheels and chain. Do not rest any objects on the battery or motor. Do not impede the drivetrain in any way.
3. Always wear shoes that will stay on your feet and will grip the pedals securely. Never ride barefoot or when wearing sandals.
4. Be thoroughly familiar with the controls of your bike.
5. Wear bright, visible clothing that is not so loose that it may accidentally catch on moving parts of the bike or be snagged by objects at the side of the road or trail.
6. Do not jump with your bike. Jumping with a bike puts incredible stress on most components, such as the spokes and pedals. One of the most vulnerable parts to jumping-related damage is your front fork. Riders who insist on jumping a bike risk serious damage to the bike as well as to themselves.
7. Be mindful of your speed and keep it at a level which is consistent with conditions. Always keep in mind that there is a direct relationship between speed and control, and also between speed and component stress.
8. Always follow local traffic laws.
9. Never ride while under the influence of alcohol, medication or drugs.
10. If you suffer from any health conditions, please consult your doctor before riding.
11. Never endanger yourself or others through reckless riding.
12. Please keep in mind that braking distance increases with imperfect road conditions, such as gravel or wet surfaces.
13. Please check the cable routing of the brakes before cycling. Ensure that both brakes are operational and in good condition.
14. Failure to follow this instruction manual may result in serious damage to the bike. Keep the manual. If passing the cycle on to a third party, it is essential that you include this manual along with it.

It is customary for countries with right-hand traffic to have the front brake on the left-hand brake lever and the rear brake on the right-hand lever. The opposite is generally true for countries with left-hand traffic. The table below shows several examples.

Country	Cable Routing	Country	Cable Routing
Austria	Left lever controls front brake, Right lever controls rear brake	Australia	Left lever controls rear brake, Right lever control front brake
Brazil		Indonesia	
Canada		Japan	
Denmark		Hongkong	
France		Malaysia	
Germany		New Zealand	
Italy		Singapore	
Netherlands		UK	
Portugal			
Poland			
Spain			
South Korea			
Switzerland			
Russia			
USA			

**⚠ WARNING:**

- Please follow local laws regarding age restrictions for cyclists.
- Please do not touch the hot surfaces after heavy use, such as the disc brake rotor or V-brake rim side edge.
- When folding out the kickstand, always ensure that the stand is secure and that the base is solid, so that a fall of the bicycle is prevented.

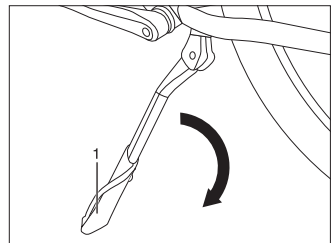

## Child Seat and Child Trailer

Never carry a passenger. Installing a child seat on the bike is not allowed. Please check with us before installing a child trailer on the bike.

**Refer to and follow national and regional regulations on the use of child seats and child trailers.**

Never attach a child seat to handlebars, seat, or front luggage carrier.

### **⚠ WARNING:**

The weight of a child seat or trailer can affect the handling of a bicycle by altering the center of gravity, weight and balance. Use of a child carrier or rack can result in a loss of control, resulting in serious injury and/or death.

## Rear Carrier Rack Payload:

The maximum payload of the rear carrier rack is already engraved on the carrier. Please check if you want a more detailed number.

## Total Weight:

The valid total weight of the electric bike states the load of the bike itself and the driver. Individually valid is the information printed on the sticker on the frame. See example below:

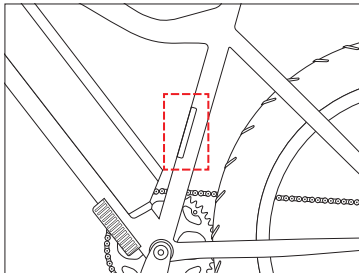

## Inflating the Tyres

### **⚠ WARNING:**

You should always check the tyre pressure before you start riding, or once a week at the minimum. Check the side wall of the tyre for the minimum and maximum inflation pressures, and always ensure that your tyres are inflated to a pressure within the indicated range. If the pressure is too low, your wheel may be damaged, or the inner tube may be pinched, resulting in a flat tyre. If the pressure exceeds the maximum recommended number, the tyre may blow off the rim, resulting in damage to the bike and injury to the rider and those nearby.

To ensure that you always have the correct and desirable tyre pressure, use a bicycle pump with a built-in pressure gauge.



## 2.3 Transport

### Transport by car

Batteries should be removed from the bike during transport by car, as they may be damaged through excessive and repeated shocks or by foreign objects striking the bike at high speed.

Please remove the batteries and keep them inside the car during transport.

### Remove the front wheel for transport

- Open the quick release lever (1) and loosen the axle nut (2) a few turns.
- Remove the front wheel (3) from the fork downwards.

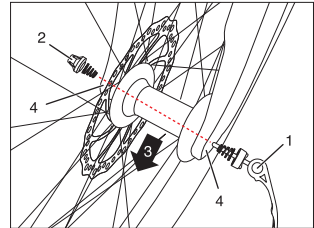

### Install the front wheel

- Insert the front wheel (3) into the end of the fork (4).

Make sure the brake rotor is centered between the brake pads (5). Adjust the disc brake until there is no obvious friction sound between the brake and disc when turning the wheel.

- Unscrew the spring and plastic cover at the end of the quick release and pass the quick release rod through the hub. Tighten the axle nut (2) and close the quick release lever (1).

The lever should be on the opposite side of the brake, it must be pointed upwards (and aligned with the fork to prevent snagging) and should be closed with noticeable counter pressure.

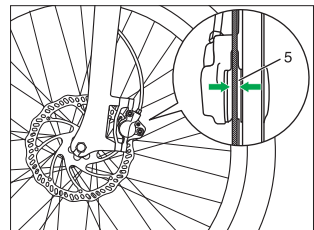

### **⚠ WARNING:**

- To avoid any danger, after you have installed the wheel, please test the brake system before cycling.
- Avoid touching the brake discs/rotors with your hand to prevent oils from your hands on the surface. If you have to clean it, use suitable brake cleaner.
- If the quick release lever is not completely closed, it may fully open again easily. This can cause the wheel to fall off the bike, leading to serious falls and bike damage. To ensure that your wheel is securely in place, the quick release lever should offer considerable resistance when closing by hand and must always be fully closed before riding.

## 2.4 Keys

Each NCM E-bike comes with two copies of the battery lock key.

Bikes with rim locks are delivered with extra keys (not the same key as the battery). Onboard charging of the battery will likely lead to infrequent usage of the battery lock key; it is needed for maintenance and repair, however, so please keep this in mind when storing the key.

- Make sure to always have at least one spare key.
- Keep spare key(s) in a safe place for repairs, maintenance and emergencies.
- Please bring the key when going to your NCM dealer for maintenance or repairs.

## 2.5 Liability Disclaimer

You are responsible for your own actions while using an electric bike. NCM Bikes is not responsible/nor liable for any accidents or injuries (whether caused by you or others) that may occur during your use. This is especially valid for cases of ungranted modifications to the setup of the bike, e.g. tuning motor or electronic parts, replacing the brake systems or other modifications that affect ride stability or safety. We recommend contacting your insurance provider to determine if your current insurance policy would cover you in the event of an accident.

## 3. INSTALLATION AND ADJUSTMENT

### 3.1 General remarks

While we are confident about the ease and your ability to assemble the bike, we highly recommend a tune up and safety check from a professional bike shop or industry partner.

### 3.2 Handlebar and Stem Assembly

1. Loosen the screws on both sides of the stem, rotate the stem 180 degrees. Make sure the stem is parallel to the frame, then fasten the two screws (torque force: 11~13N.m) and top screw (torque force: 6~7N.m).

Tool you may need: 5mm Allen wrench.

2. Remove the 4 screws and the cover from the stem.

Tool you may need: 4mm Allen wrench.

3. Put the handlebar on the groove of the stem, making sure the thread is centered.

4. Install the cover and 4 screws on stem. Adjust the angle of the handlebar if necessary, then fasten the 4 screws and make sure the gap between stem and stem cover is consistent front to back. Torque force: 5~7N.m

Tool you may need: 4mm Allen wrench.

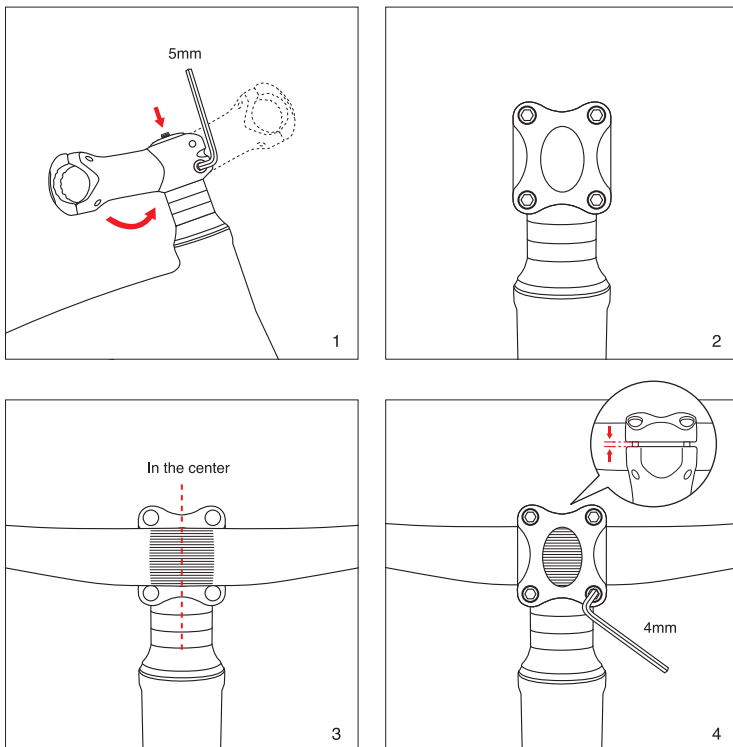

### 3.3 Assembly of the Pedals

- Identify your pedals: check the letters on the pedals, "L" or "R".
- The "R" marked pedal is for the right (when facing the forward direction). For attachment to the crank, tighten clockwise.
- The "L" marked pedal is for the left. For attachment, tighten counterclockwise when facing directly.

First screw on the pedals by hand and pedals should thread in by hand all the way, then use the wrench provided to tighten them to a point where you estimate the driver cannot loosen them by the force of feet during normal usage.

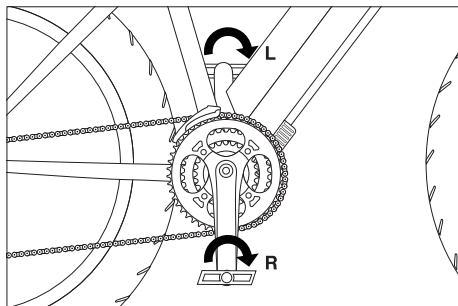
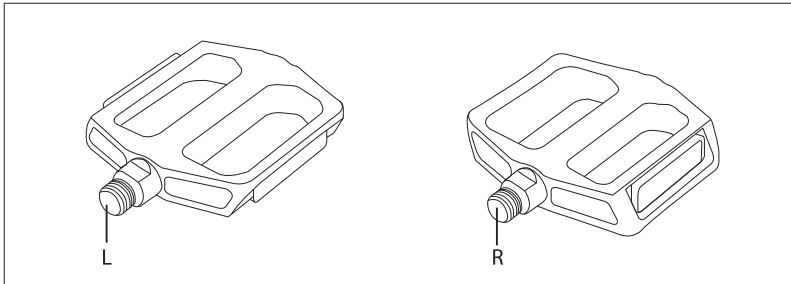

**⚠ WARNING:**

When installing the pedals, please avoid cross-threading the bolt into the crank arm as it will cause the threads to strip.

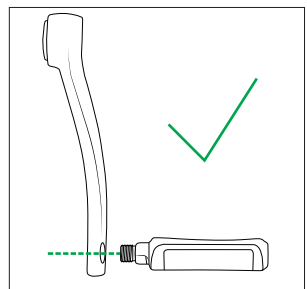
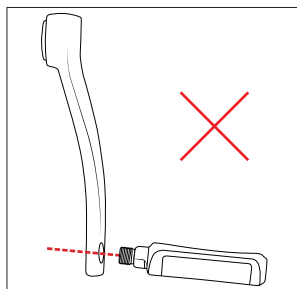
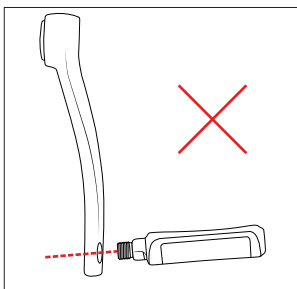

### 3.4 Seat Position

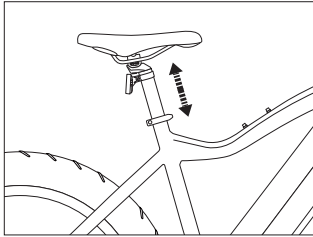

To enable comfortable, fatigue-free and safe riding, the saddle and handlebar height should be adjusted to the body size of the rider.

The saddle height is correct if the leg is near full extension while the foot is resting flat on the pedal in the bottom position of the crank cycle. The toes must still be be able to touch the ground comfortably.

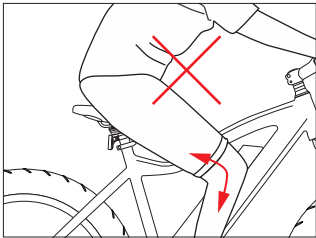

Too low

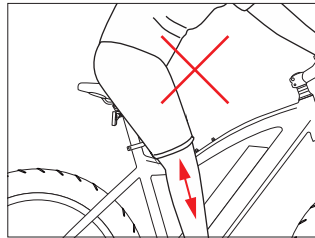

Too high

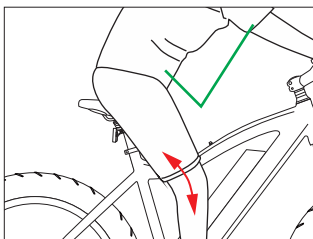

Optimal

### 3.5 Saddle Height

The quick-release lever must require noticeable effort to put into fully closed position to prevent any undesired movement while riding.

**⚠ WARNING:**

An improperly closed quick release lever can open again or have limited ability to keep the saddle in place. This may cause the saddle to suddenly drop into the seat tube, potentially leading to serious falls and injury.

There is a minimum insertion line marked on the seat post (Failure to observe the minimum insertion line can result in serious injury); please ensure the seat post is always inserted into the seat tube beyond this line (the line must be inside the seat tube).

- Loosen the quick release lever at the top of the seat tube, determine the appropriate saddle height and tighten the clamp.
- The clamping force can be adjusted by adjusting the bolt on the quick release lever.
- The quick release lever must be closed with considerable counter pressure.

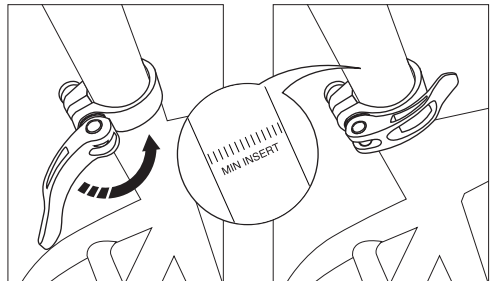

### 3.6 Saddle Adjustment

The saddle can also be tilted and adjusted in the forward/back direction.

- Loosen the bolt (1) at the bottom.
- Adjust the saddle tilt by pressing down on the front or rear of the saddle
- Move the saddle forward or backward to adjust for arm/torso length and desired riding position.
- Tighten the bolt (1) to secure the saddle.

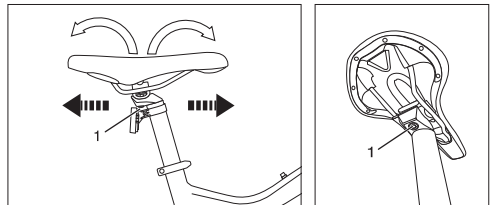

**⚠ WARNING:**

To avoid discomfort, the saddle should generally be set as horizontal as possible.

### 3.7 Locking the Suspension Fork

- The suspension is locked with the knob (2).
- Turn the knob (2) to the locked position.
- The lock function is exclusive to the + models.

**⚠ WARNING:**

Do not make any further changes to the suspension fork.

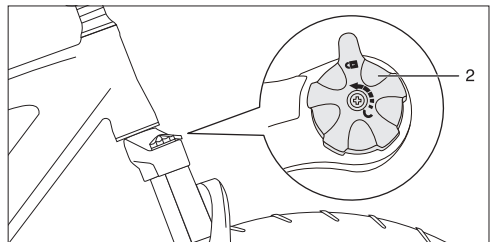

## 3.8 Brakes

### 3.8.1 General

In most countries, bicycles are made so that the left brake-lever controls the front-wheel brake; to change this, please contact your dealer for help. Keep in mind Section 2- Important safety information.

If your bicycle has two hand brakes, apply both brakes at the same time for optimal stopping distance.

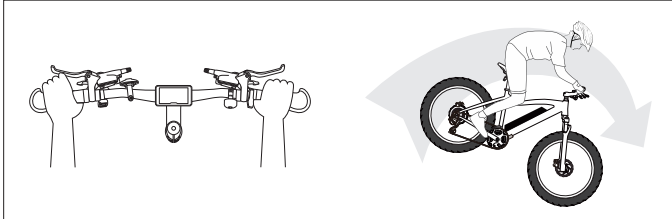

#### **⚠ WARNING:**

Overuse or incorrect use of a front-wheel brake can cause the rear wheel to lift off the ground, resulting in decreased control of the bike or even flipping the bike and rider in the forward direction; this can lead to serious injury and bicycle damage. Be careful when applying the front brake, and avoid using it without also using the rear brake. Ideally, both brakes should be applied at the same time, with the rider moving rearward on the bicycle depending on the amount of braking pressure applied.

### 3.8.2 Brake Adjustment

#### **Disc brakes**

When the wheel is out of the frame, do not operate the brake lever. With some brakes, the pads automatically adjust their clearance such that you will not be able to re-insert the disc.

#### **Aligning a hydraulic disc brake**

1. Loosen the two alignment bolts but do not remove them.
2. Slowly rotate the wheel and check the space between rotor and brake pads; adjust the position of the brake pads so that the rotor is not rubbing and is slightly closer to the outer pad (the clearance between rotor and pad should be just enough to prevent rubbing). Make sure the rotor and pads are parallel to each other. Tighten the bolts when the adjustment is finished.

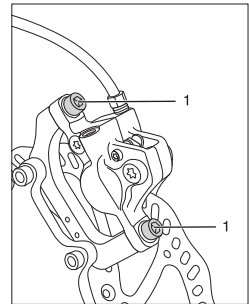

1. Alignment Bolts

#### **⚠ WARNING:**

If the disc rotor is curved or broken, please replace the rotor first.

## 3.9 Shifter and Derailleur Adjustment

### Front Derailleur Adjustment

Set the chain on the smallest chainring and tighten the tuning bolt on the lever. Adjust the L screw on the front derailleur so that it is 1 to 1.5mm away from the chain. You can loosen the cable first if needed, then tighten it again later.

Shift to the bigger chainring of the crankset and smallest chainring/cog of the freewheel or cassette.

Check whether the outer chain guide-plate of the derailleur touches the chain or if the spacing is too large, adjust the H screw to avoid either scenario. Maintain a distance of 1 to 1.5mm. If the spacing is too large, simply adjust the H screw. Check and adjust the H and L screws until the shifter functions smoothly.

### Rear Derailleur Adjustment

Step 1: Make sure the rear derailleur is shifted all the way down to the smallest cog.

Step 2: Turn your barrel-adjuster all the way tight so that you have room to adjust it later.

Step 3: Adjust the high limit by rotating the screw marked "H" on your derailleur so that it lines up with that smallest cog.

Step 4: Tighten the tension in your cable by unscrewing the cable anchor, pulling the cable tight, and screwing the anchor back on tight.

Step 5: Shift your rear derailleur to the 4th or 5th cog.

Step 6: To adjust the index, turn your barrel-adjuster so that the derailleur pulley lines up underneath the correct (chosen) cog. With a Shimano rear derailleur, you want to line up the pulley slightly inboard of the cog. Perform some practice shifts to make sure it is adjusted properly.

Step 7: Shift your rear derailleur to the largest cog.

Step 8: Adjust the low limit by rotating the screw marked "L" on your derailleur so that it lines up with the largest cog.

Step 9: Adjust the B-tension screw so that the pulley on the rear derailleur is as close to the largest cog on the cassette as possible without dragging.

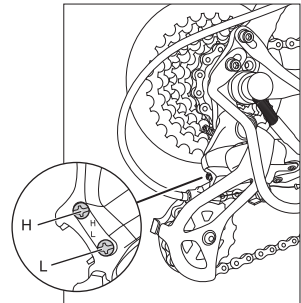
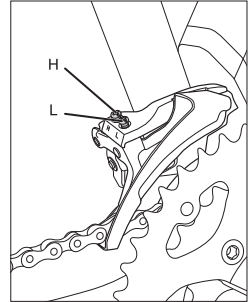

## 4. E-PARTS OVERVIEW

### 4.1 Explanation

NCM E-bikes are equipped with components that work together to give you a smooth, powerful and effortless riding feel. Our pedal-assist system consists of the following:

#### Battery

NCM E-bikes' integrated lithium-ion battery packs are some of the highest capacity packs available on the market, with the NCM Aspen+ storing up to 768Wh of energy. The packs consist of high-density cells, meaning that our designs remain sleek and light without any sacrifices to battery capacity. Furthermore, most of our designs boast a built-in USB port, perfect for charging your cell phone or other small electronic devices on the go.

#### Motor Powered by Das-Kit

Our proprietary Das-Kit X15F motor stands at the top of the market, offering smooth, powerful performance while remaining surprisingly quiet. Rated at 250W(300W for NZ market), it achieves a maximum of 55Nm (newton metres) of torque, ensuring that no hill is too steep and no terrain too rugged for the NCM Aspen+. Its versatility allows for triple chainring cranksets, giving the rider more options and reducing the energy usage of both the rider and battery.

#### Display

The Das-Kit control panel gives the rider full command over the electric system, and its simple setup provides all the information you may need about your E-bike at the quick touch of a button, allowing you to spend more time enjoying the world around you. The display provides the following information:

- Battery level indicator
- Support level indicator
- General indicators: speed, distance etc.

When using the brake with the brake sensor, the sensors inside cause the engine's support to stop immediately. Another sensor, within the crankset, also serves to stop the motor when the rider stops pedaling.

The bike can also be used without electrical support from the motor; by setting the support level to 0, the E-bike will behave like a traditional bicycle. An empty battery will not render your bike unusable.

### 4.2 Battery & Charger

#### 4.2.1 Overview

- A Battery
- B Charging Socket
- C Battery Handle
- D Capacity Level Light
- E Power Button
- F USB Port (output: 5V 700mA)

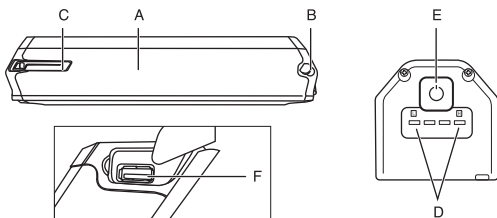

**⚠ WARNING:** (Sticker on the battery)

Please ensure that the battery is locked before use.



**⚠ ATTENTION:** (Sticker on the battery)

- Secondary (rechargeable) Li or Li-ion.
- Do not use or charge the battery at high temperature.
- Do not short circuit the positive(+) and negative(-) connectors of the battery.
- Do not immerse the battery in water or acidic liquid. Keep the battery away from fire and high heat.
- Do not disassemble the battery or battery case.
- Please store the battery in a clean and dry environment. Charge the battery for two hours every three months if the battery is not being used.
- Please charge the battery with the specified charger.

- A AC Plug (type will vary)
- B Charger
- C Charging Indicator
- D Battery Plug

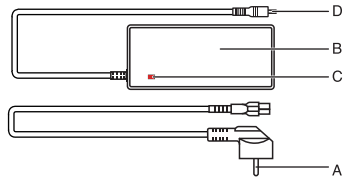

**4.2.2 General Remarks**

- Stop charging the battery immediately if you notice anything unusual, such as smoke or a strange smell; take out the battery and store it outside of the house, then take the battery to an authorized NCM dealer or experienced technician for service or replacement.
- In the unlikely case that the battery catches fire, DO NOT attempt to put it out with water. Use sand or another fire retardant instead and call emergency services immediately.

**4.2.3 Installing and Removing the Battery**

The battery (1) is secured with a lock.

-Unlock the battery and pull it out with the handle (2).

-Insert the battery (1) into the frame until it stops.

-Remove the key from the lock (3). Ensure that the battery is well secured.

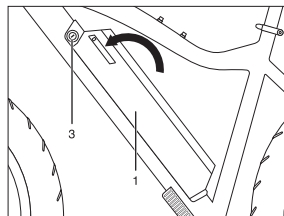
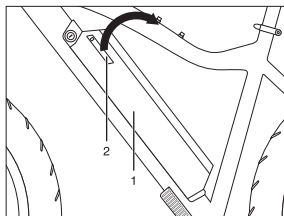

**4.2.4 Charging**

- Charging at temperatures below 0°C or above 60°C can cause the battery to charge insufficiently and can be harmful to the life of the battery.
- During charging, the charger's LED light will be continuously red.
- Charging is completed when the charger's LED turns green.

**Integrated downtube battery outside the bike**

1. Insert the key to unlock the battery, then pull the battery backwards at the top.
2. Take out the battery.
3. Connect the charger to the battery.
4. Connect the charger to an AC outlet.
5. Charging procedure can be stopped at any time.
6. Disconnect the charger from the AC outlet first and then from the battery.
7. Reinstall the battery and ensure that it is correctly aligned at the bottom.
8. Push down on the top of the battery until you notice a 'click' in order to ensure that the battery is properly secured.
9. Pull out the key.
10. Your NCM E-bike is ready for use.

**Integrated downtube battery inside the bike**

1. Connect the charger to the battery.
2. Connect the charger to an AC outlet.
3. Charging procedure can be stopped at any time.
4. Disconnect the charger from the AC outlet first and then from the battery.
5. Your NCM E-bike is ready for use.

**4.2.5 Usage**

When the battery power level drops to 1 bar, assistance from the motor will stop. If there are lights connected to the battery, they will remain in operation for approximately two hours.

Remaining power in the battery can be checked by pressing the power button on the battery next to the LED indicators. The handlebar mounted display will also indicate remaining power level when the bicycle is in use.

Perform a complete discharge of the battery (by riding your E-bike until the battery is completely empty) after 15 normal charges or every three months; this will help increase the life of the battery. The charging time will be around 7 hours per one time. Please do not charge the battery for more than 14 hours at a time (the battery will be fully charged much sooner).

** ATTENTION:**

For 36V battery: fully charged voltage: 42V, low voltage: 31V.

For 48V battery: fully charged voltage: 54.6V, low voltage: 42V.

This means the customer needs to charge the battery when the display shows voltage no less than 31V or 42V respectively.

**4.2.6 Storage**

If the bike is not in use for a period of longer than one month, it is best to store the battery:

- At 40%-60% of its capacity, charged once a month for 30 minutes.
- Detached from the bike.
- At temperatures between 0°C and 40°C.

If not in use, the battery should be checked once a month and should have at least one LED light blinking, indicating remaining charge. Charge the battery if necessary.

It is important to charge the battery every three months (for one or two hours) at the minimum. Failing to do so can cause harm to the battery and could result in the warranty of the battery becoming void.

## 5. DISPLAY

### 5.1 APPEARANCE

- A Better Display. A Smart Display.
- Easy View 4" Display Panel.
- Superior Anodizing Aluminum Alloy Frame.
- PMMA Waterproof Cable Housing.
- Easy Control with Large Buttons.

### 5.2 NORMAL OPERATION

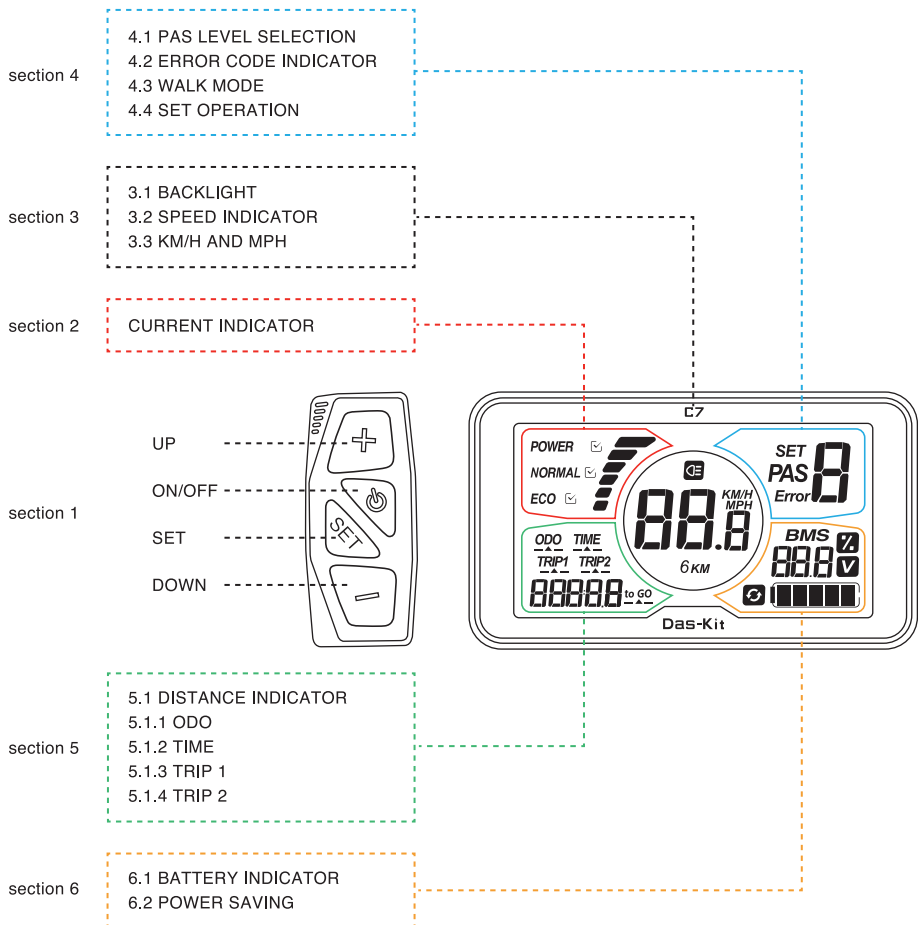

### FULL VIEW AREA

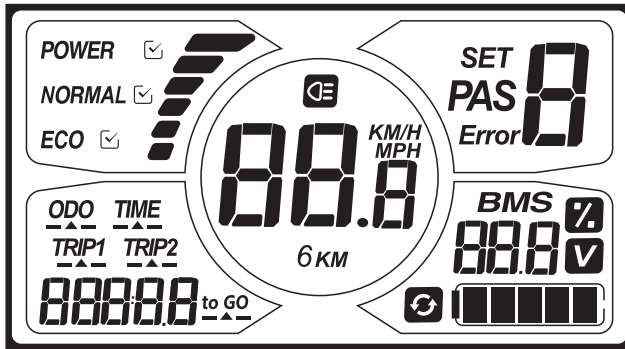

### NORMAL VIEW AREA

With the display on, the default indicators are current indicator, trip 2, speed, PAS level, and battery indicator as shown in the figure below.

Press SET to change the display information.

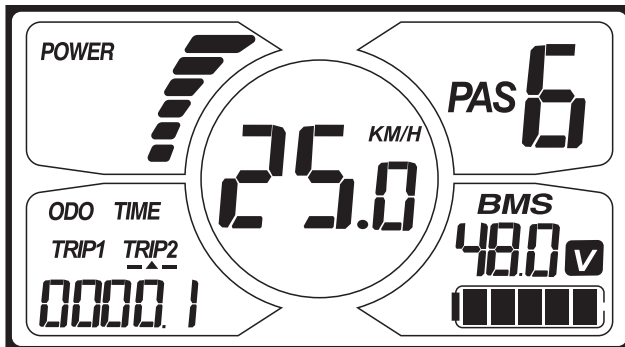

## Section 1: ON/OFF

Press ON/OFF to activate the display. With the display on, press ON/OFF for 2 seconds to turn off power. With the display off, there is no battery power consumption.

※ The panel will power off automatically when speed is 0km/h(0mph) for 5 minutes.

## Section 2: CURRENT INDICATOR

The current indicator shows the present discharging current of the controller: each segment is 2A, six segments are  $\geq 12A$ .

(The bar graph shows the power output of the motor in real time. 1 bar indicates low power, full bars maximum power.)

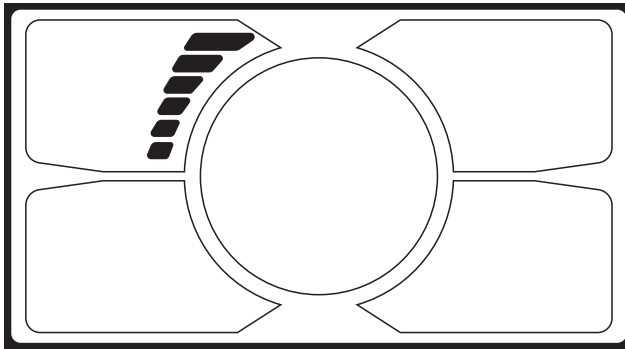

## Section 3:

### 3.1 BACKLIGHT

Press ON/OFF to turn on the backlight. Press it again to turn off the backlight.

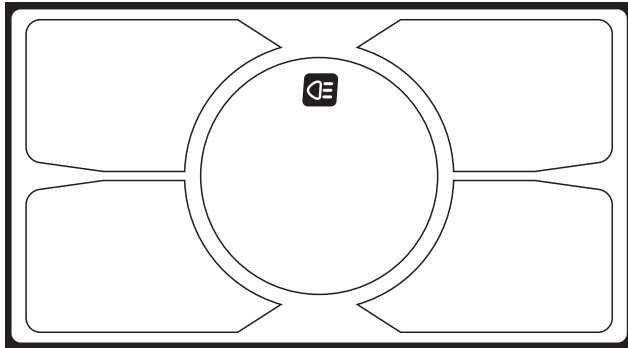

### 3.2 SPEED INDICATOR

The central area displays the current riding speed of the E-bike. The speed display is as below.

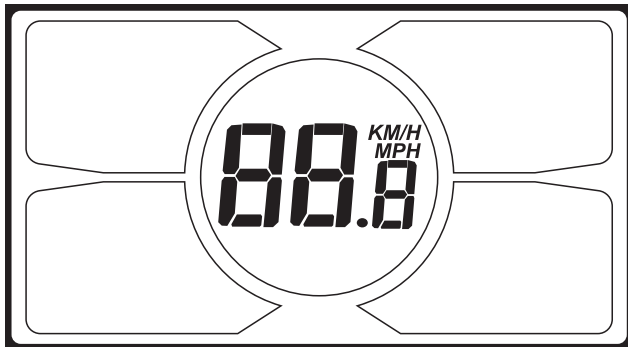

### 3.3 KM/H and MPH

Selecting KM/H or MPH for the speed and mileage will switch all indicators to the selected unit of measurement.

## Section 4: OPERATION

### 4.1 PAS LEVEL SELECTION

Press UP (+) or DOWN (-) to change the PAS level and thus change the power output of the motor. The default mode is PAS 1 and assistance ranges from level 0 to level 6. Level 0 provides no assistance from the motor.

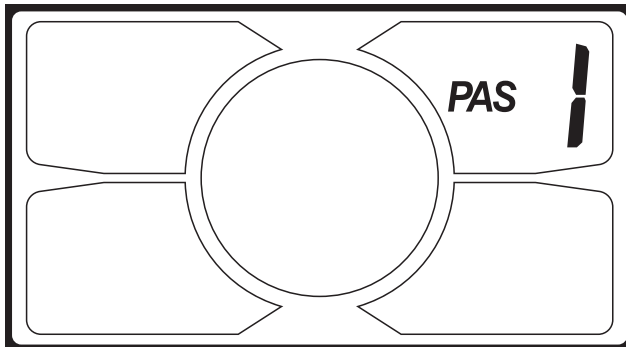

#### 4.2 ERROR CODE INDICATOR

If there is something wrong with the electronic control system, the display will flash at 1Hz and show the error code automatically. Different error codes represent different faults in the system, consult the error code table on the last page for details(5.3).

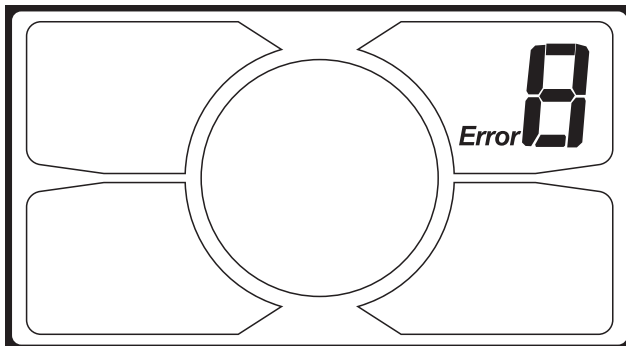

※ The display cannot return to normal status until the problem is solved, the E-bike's electric components will not operate if there is an error in the system. However, the bike can still be operated conventionally (without electric assistance).

※ Hold ON/OFF and SET at the same time to show the error code.

### 4.3 WALK MODE

Hold DOWN (-) for 2 seconds to enter the power-assisted walk mode. When the 6KM icon is lit, the E-bike will travel at 6km/h(3.7mph) without the need for the rider to pedal. Assisted walk mode will cease when the button is no longer being pressed.

### 4.4 SET OPERATION

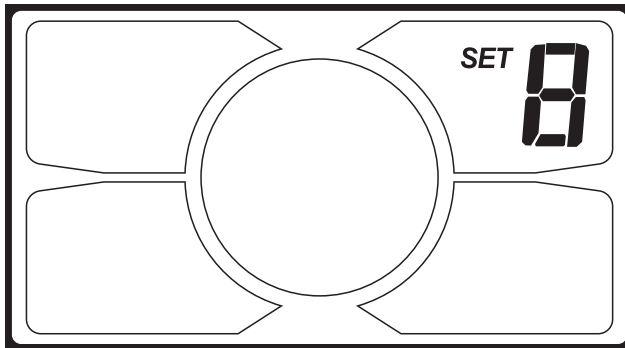

#### 4.4.1 KM/H and MPH

Press the UP (+) button for 8 seconds to enter the unit of speed selection mode, then press UP (+) or DOWN (-) to switch between KM/H and MPH. Press SET to confirm and exit.

#### 4.4.2 Trip 1 Distance

On the Trip 1 display, press the SET button for 2 seconds and the display icon will flash at 1 Hz, and keep holding SET for 2 more seconds to clear Trip 1.

## Section 5:

### 5.1 DISTANCE INDICATOR

With the display on, press SET to select between ODO, time, trip 1 and trip 2.

#### 5.1.1 ODO

The ODO (odometer) records the riding mileage from the very start of the display's usage;

#### 5.1.2 Time

The riding Time indicator is automatically reset when the display is shut off.

#### 5.1.3 Trip1

Shows the riding distance of this time.



**5.1.4 Trip2**

Trip 2 shows the previous riding distance for 30s after the display is turned on; it can be reset automatically to start to record the current session's mileage.

**Section 6:**

**6.1 BATTERY INDICATOR**

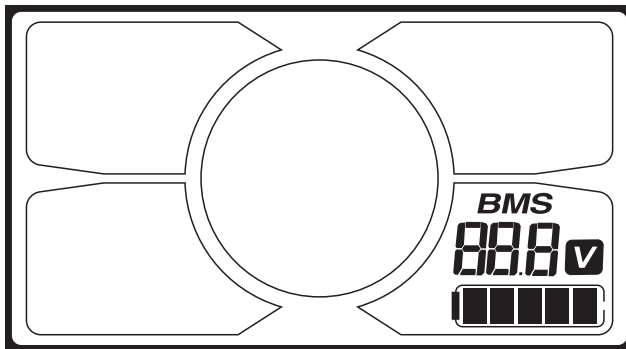

**6.1.1 Battery Residual Capacity Indicator**

The battery capacity indicator has five segments, each segment representing 20% of battery capacity. When the battery is full, the five segments are all lit. If the battery is low, the battery display area will flash, indicating that pedal assistance will soon cease and that the battery needs to be recharged.

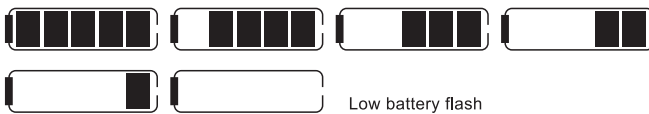

**6.1.2 Battery Voltage**

The present voltage of the battery is displayed above the battery capacity indicator.

**6.2 POWER SAVING**

When the riding speed is 0km/h(0mph) for 5 minutes, the system will power off automatically to save battery.

### 5.3 ERROR CODE TABLE

Each error code corresponds to a specific fault in the system. Take the E-bike to your dealer to have the error resolved.

Error code	Definition
0	Normal
1	Current error or MOS (semiconductor) damaged
2	Throttle error (detection after turning on)
3	Motor missing phase (losing power)
4	Hall signal error (electromagnet in incorrect position)
5	Brake error (detection after turning on)
6	Under voltage
7	Motor stalling
8	Error in communication with controller
9	Error in communication with display

**If you still have some questions about the display, please contact your NCM dealer.**

## 6. RECOMMENDATIONS AND MAINTENANCE

### 6.1 General Requirements

NCM E-bikes use metal shells to cover the electric components, so we strongly advise against the use of excessive water to wash the shells and parts around them. Use a soft cloth with a neutral solution to wipe the dirt off the shells. Afterward, wipe everything dry with a clean soft cloth.

Do not use high-pressure water or air hoses for cleaning; this can force water into electrical components, which may cause malfunctioning.

Do not wash plastic components with excessive water. When the internal electrical parts are affected by water the insulator may corrode, leading to power-drain or other problems.

Do not use soap solutions to wash the metal components. Non-neutral solutions may cause discoloration, distortion, scratching, etc.

#### Avoid leaving the bike outdoors

When not riding, keep the bike in a location where it will be protected from snow, rain, sun, etc. Snow and rain can cause the bike to corrode. Ultraviolet rays from the sun can cause unnecessary fading of paint or crack any rubber or plastic on the bike.

#### Recommended Torque Values

<b>Front Wheel Nuts</b>	30-35 Newton Meters	22.1-25.8 ft.-lb.
<b>Rear Wheel Nuts</b>	30-35 Newton Meters	22.1-25.8 ft.-lb.
<b>Seat Post Bolt</b>	17-19 Newton Meters	12.6-14 ft.-lb.
<b>Brake Caliper Nut</b>	7-11 Newton Meters	5.2- 8.1 ft.-lb.
<b>Handlebar and Head Stem Nut</b>	10-15 Newton Meters	7.4-11.1 ft.-lb.
<b>Headset and Head Stem Nut</b>	M4 : 5-6 Newton Meters M5 : 7-9 Newton Meters M6/M7 : 12-14 Newton Meters	M4 : 3.7-4.4 ft.-lb. M5 : 5.2-6.6 ft.-lb. M6/M7 : 8.9-10.3 ft.-lb.
<b>Head Stem and Front Fork Screw</b>	18-20 Newton Meters	13.3-14.8 ft.-lb.
<b>Crankset Nuts</b>	35-45 Newton Meters	25.8-33.2 ft.-lb.
<b>Brake Rotor Bolts</b>	9-11 Newton Meters	6.6-8.1 ft.-lb.

### 6.2 Maintenance Schedule

To keep your NCM E-bike in optimal condition and your riding experience at its most enjoyable, we strongly recommend following the suggested maintenance schedule. You should study it and allow it to become second nature to your riding.

Maintenance Schedule	Each ride	Weekly	Monthly	6 Monthly	Yearly
Tyre pressure	×				
Tyre condition	×				
Visual inspection	×				
Brake lever pressure	×				
Quick releases	×				
Handlebar alignment	×				
Saddle alignment	×				
Battery pack locked	×				
Wheel check	×				
Inspect frame condition (include welds for fissures)		×			
Clean and lubricate chain		×			
Check brake pads		×			
Lubricate forks			×		
Lubricate brakes & cables			×		
Lubricate folding mechanism			×		
Check all bolts and torque settings			×		
Clean bicycle			×		
Charge battery			×		
Check wheel spokes			×		
Inspect rim condition			×		
Inspect saddle, rails and clamp			×		
Grease pedal bearings				×	
Check hub bearings				×	
Check headset bearings				×	
Check bottom bracket bearings				×	
Replace brake pads					×
Replace brake cables (depends on use)					×
Replace tyres (depends on use)					×

 **WARNING:**

—As with all mechanical components, electrically power assisted cycles (EPAC) are subjected to wear and high stresses. Different materials and components may react to wear or stress fatigue in different ways. If the design life of a component has been exceeded, it may suddenly fail, possibly causing injuries to the rider. Any form of crack, scratches or change of coloring in highly stressed areas indicate that the life of the component has been reached and it should be replaced.

## 6.3 Troubleshooting

### **How do I know how much charge my battery has when it is not connected to the bike?**

- By pushing the power button on the battery, LEDs will light up, indicating the remaining capacity.

### **How can I test my battery capacity?**

- Please contact NCM to arrange the return of your battery for testing. If the battery tests above 85% capacity within the first year (from purchase date) you will be liable for return freight. If it is tested and is under capacity within the warranty period, your battery will be replaced.

### **What happens if my battery goes empty while I'm riding my E-bike?**

- Assistance will stop when only 1 bar remains on the indicator. Your E-bike can still be ridden without assistance.

### **Should I always empty my battery completely before recharging?**

- There is no need to do a complete discharge every time. We recommend doing a complete discharge every 2-3 months.

### **What should I do if the rim has a buckle or spokes coming loose all the time?**

- Take your bike to a qualified wheel builder or technician for service. The issue may be as simple as adjusting the spoke tension.

### **My display turns on, but the motor does not activate. What should I do?**

- Check the motor plug from the controller. This is a very stiff connection and will not work unless the plug is all the way in to the indicator line. The twisting of the handlebar can sometimes cause the plug to pull out slightly if there is not enough slack in the motor cable.

### **The display won't turn on unless the battery charger is plugged in?**

- Please refer to the display manual for error code definition and if needed, report the error code to NCM.

### **Why do competitors' motors make a different sound?**

- NCM uses a different internal structure than some competitors. As a consequence, we have a slightly higher frequency and better torque.

**If you have any further questions, please feel free to contact us by email at [support.au@ncmbikes.com](mailto:support.au@ncmbikes.com), [support.uk@ncmbikes.com](mailto:support.uk@ncmbikes.com), [support.nz@ncmbikes.com](mailto:support.nz@ncmbikes.com).**

## 6.4 Definition of Tampering and Recommendations

Category 1	Category 2	Category 3	Category 4
Components which can only be replaced after approval from the bicycle manufacturer / electronic system provider	Components which can only be replaced after approval from the bicycle manufacturer	Components which can only be replaced after approval from the bicycle or component manufacturer	Components which can be replaced without approval
Motor Sensors Controller Electric cables Controls on the handlebar Display Battery Battery charger	Frame Fork (including suspension) Hubmotor wheel Brake system Brake shoe Luggage carrier Bottom bracket	Cranks Wheel without hub motor Chain or belt (at original width) Rim tape Tyres (at original ETRTO specifications only) Mechanical / Hydraulic brake cables Brake system (for drum, disc and roller brakes) Handlebar and stem (without alterations to the handlebar and stem) Saddle and seat post (maximum variation from original should not exceed 20mm) Headlight	Headset Pedals (at the same width as the originals) Derailleurs Shifters Shifting inner / Outer cables Chainring / Belt drive ring Cassette / Freewheel or cogs (when the cogs are the same as the originals) Chaincase Mudguards (only the same size as the originals and mounted at least 10 mm distance from the tyre) Spokes Inner tubes Dynamo Front light / Front reflector Rear light / Rear reflector Wheel reflectors Kickstand Grips (with a screw clamp only)

### **WARNING:**

Modifications to any part of your bike, such as the fork or frame, may make that part or the entire bike unsafe. A poorly installed or modified component can increase the stress on all other parts, greatly increasing their chance of failure. Modifications can also adversely affect the handling of your bike, resulting in loss of control, falls and serious injury. Please do not add, remove, or modify parts of your bike in any way before consulting with a trained bike technician. We recommend you consult with us at NCM before you make modifications or add parts, in order to confirm their safety and compatibility with your bike.

## 7. TECHNICAL DATA

Component	NCM Aspen+ 26" 48V
<b>Motor</b>	Das-Kit, X15F, rear drive motor, 48V 250W (300W for NZ market)
<b>Battery</b>	Das-Kit, i5-4816P, 48V 16Ah, 768Wh, with USB port
<b>Display</b>	Das-Kit, C7, LCD, 6 levels
<b>Throttle (for NZ market)</b>	T6-20
<b>Front Fork</b>	RST, Guide-TNL-26", with oil suspension and lock system
<b>Crankset</b>	Das-Kit, CM48, 28/38/48T*170mm
<b>Brake Levers</b>	Left / Right: Tektro, HD-E350, Hydraulic brake lever with brake sensors
<b>Brakes</b>	Front / Rear: Tektro, HD-E350, Hydraulic disc brakes
<b>Front Derailleur</b>	Shimano, Altus, FD-M310
<b>Rear Derailleur</b>	Shimano, Acera, RD-M360
<b>Freewheel</b>	8-speed, 11-32T
<b>Tyres</b>	CST, C1752, 26*4.0
<b>Total Weight (driver+bike)</b>	125kg / 275lbs
<b>Max Speed</b>	25km/h / 15.5mph (unrestricted for NZ market)

In order to meet our customers' requirements as much as possible, NCM reserves the right to modify the characteristics of its products at any time, without notice. Please contact an authorized NCM distributor for assistance.

## 8. WARRANTY

Your NCM E-bike comes with a limited warranty. Please visit [ncmbikes.com](http://ncmbikes.com) or your local NCM dealer for details.

EN15194 CE



Leon Cycle Pty Ltd | 3/45 Leakes Road Laverton North, Vic 3026, Australia | [support.au@ncmbikes.com](mailto:support.au@ncmbikes.com)  
Leon Cycle Ltd. | Unit 2 Wharf Mill, 27 Caroline Street, Wigan, Greater Manchester, WN3 4FN, UK | [support.uk@ncmbikes.com](mailto:support.uk@ncmbikes.com)  
Leon Cycle NZ Limited | Level 4, 4 Graham Street, Auckland, 1010, NZ | [support.nz@ncmbikes.com](mailto:support.nz@ncmbikes.com)  
[www.ncmbikes.com](http://www.ncmbikes.com)  
All rights reserved.

KAU/KUK/KNZ02