

**ALLIBERT** 

# LOUNGE CHAIR

---

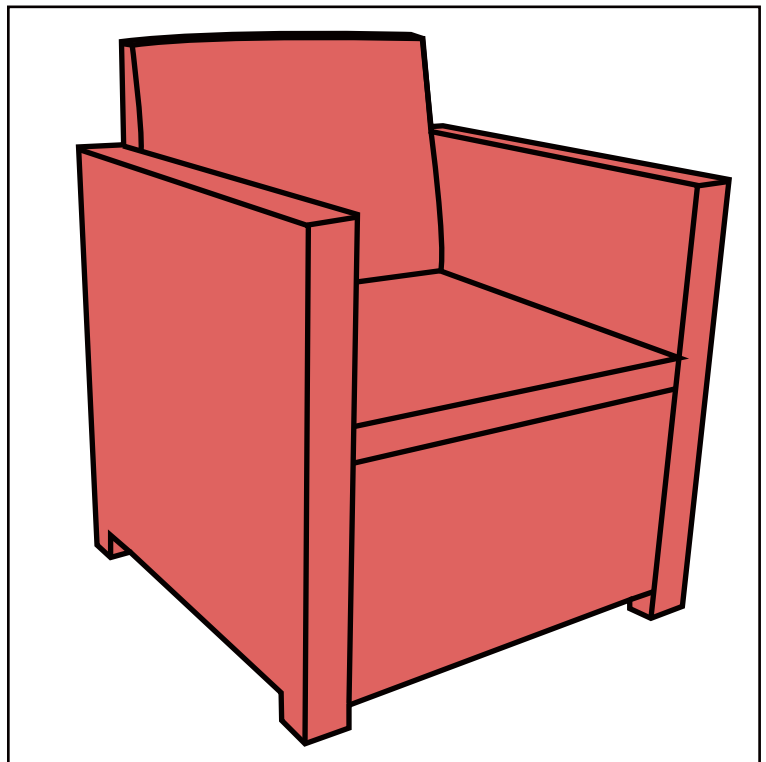
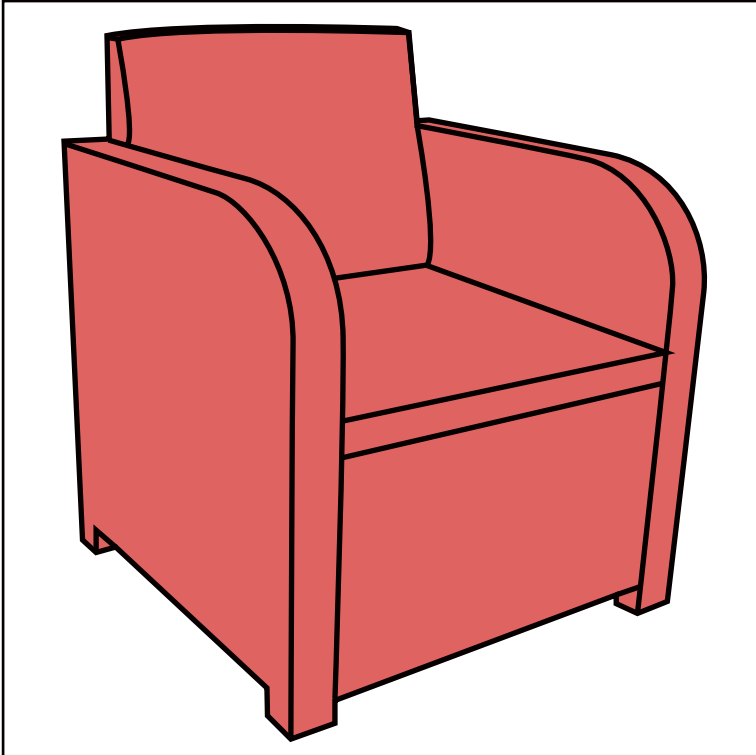

"WICKER LOUNGE CHAIR" V1.3 / 553299 / 442041



NEN 581

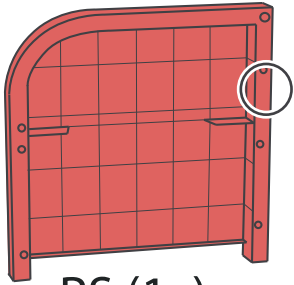
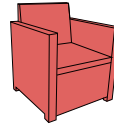
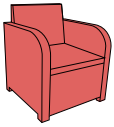

RS (1x)

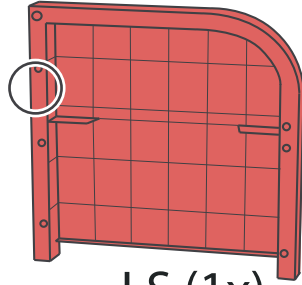

LS (1x)

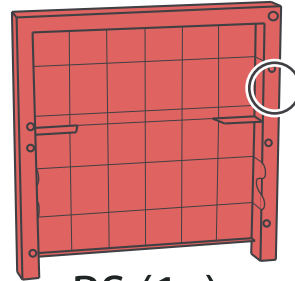

RS (1x)

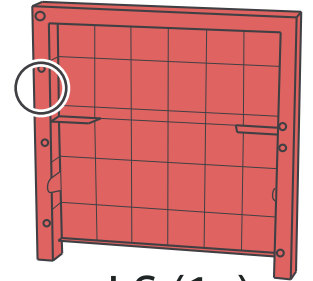

LS (1x)

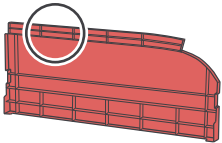

SCR (1x)

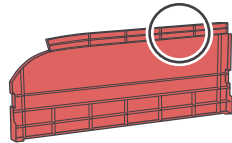

SCL (1x)

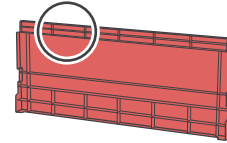

SC (2x)

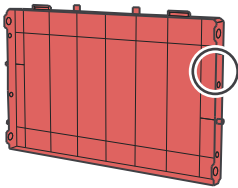

F1 (1x)

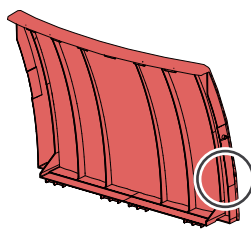

BC (1x)

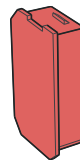

NA (2x)

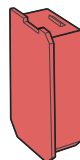

NB (2x)

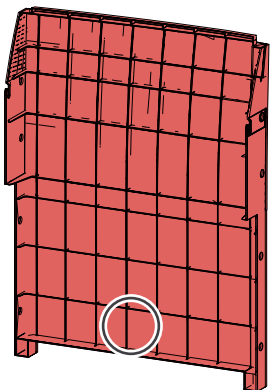

B (1x)

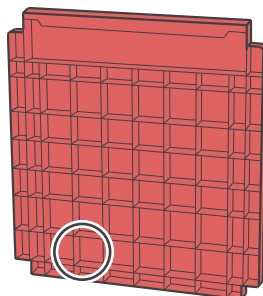

S1 (1x)

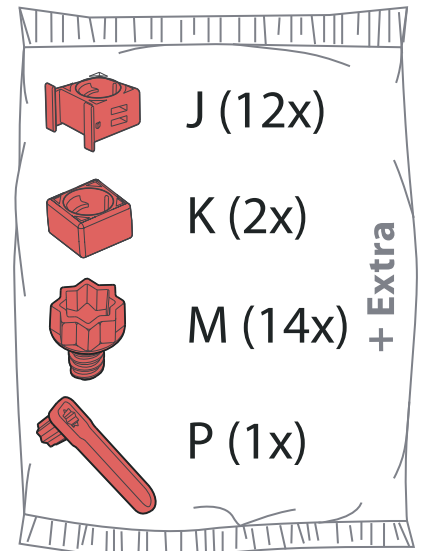

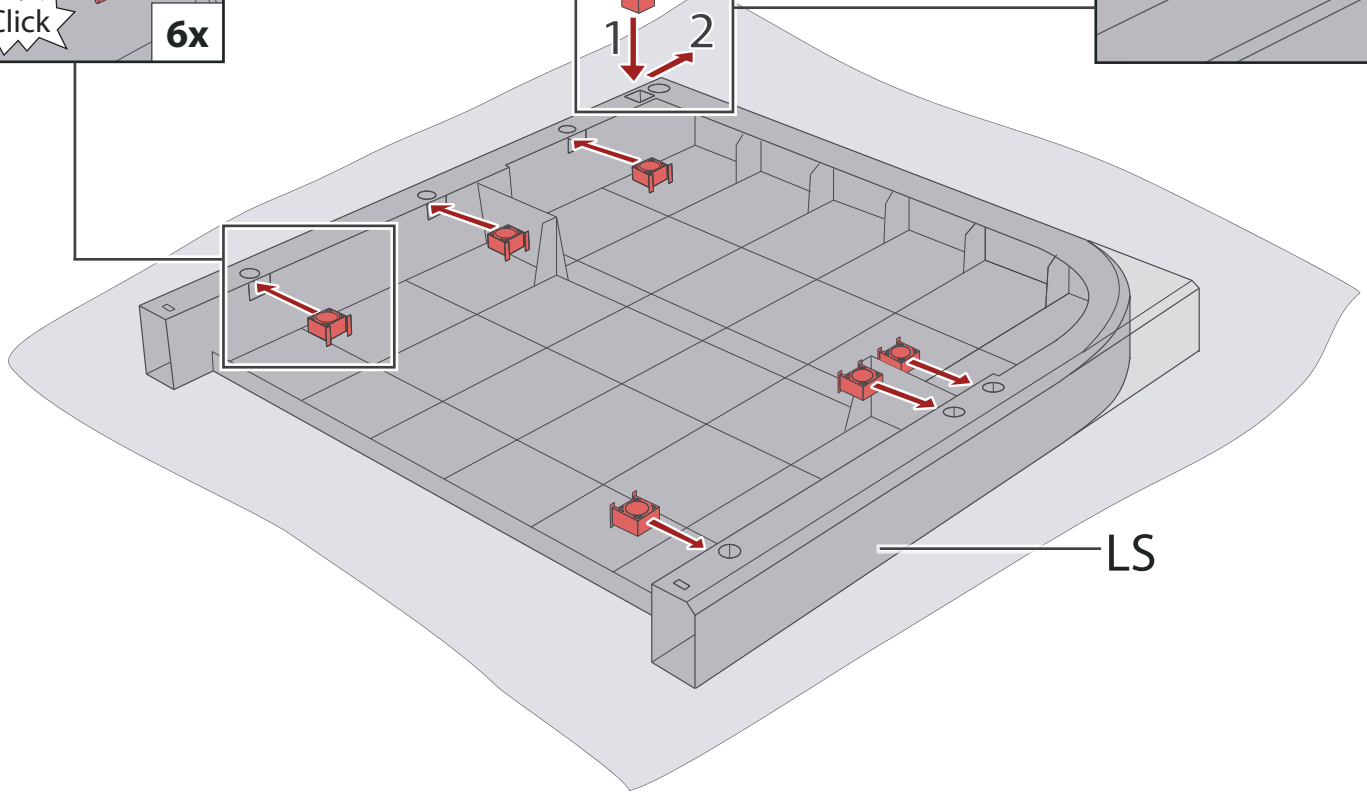
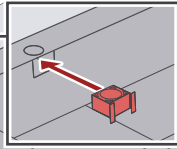
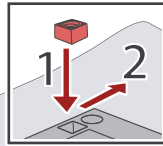
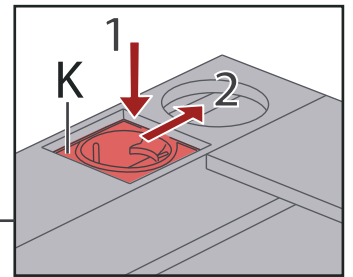
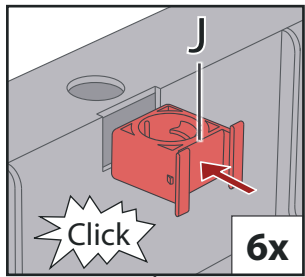

1

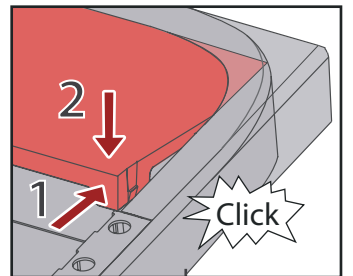

SC/SCL

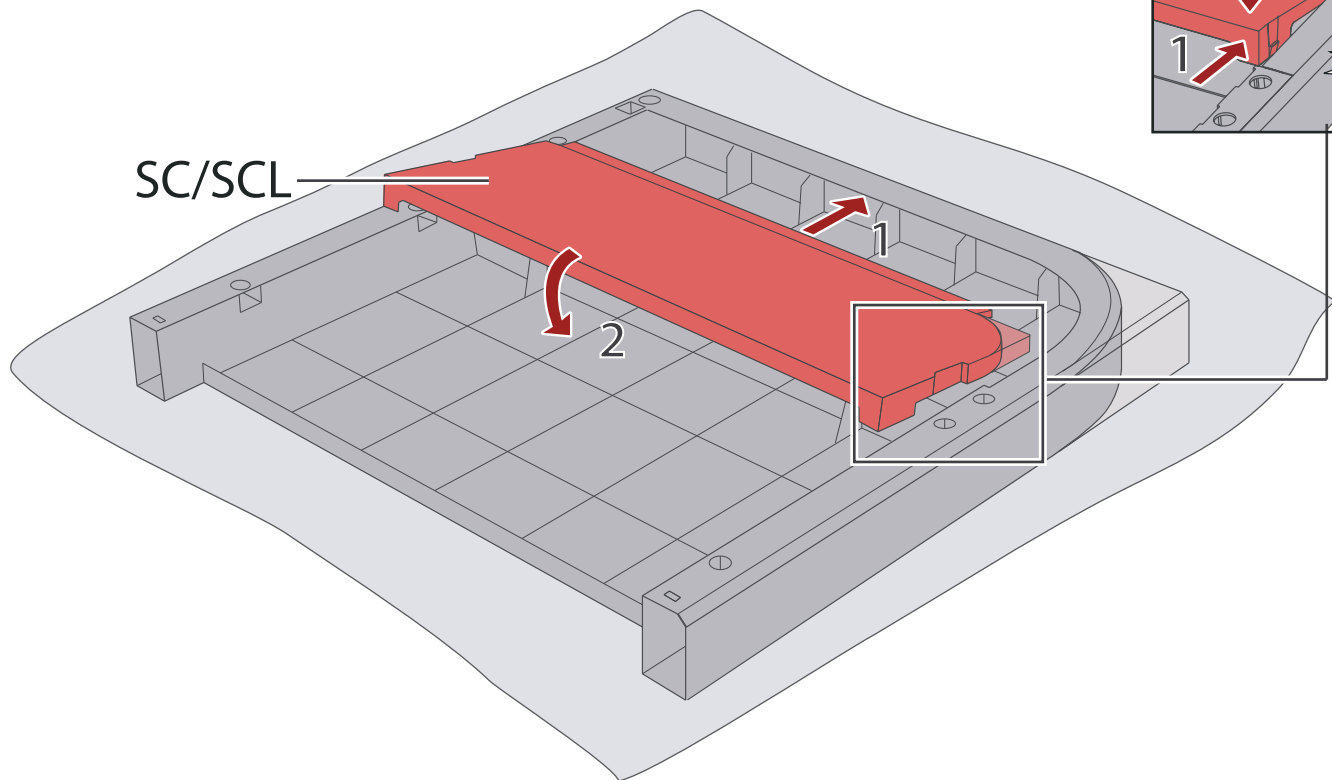

2

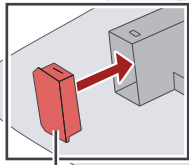
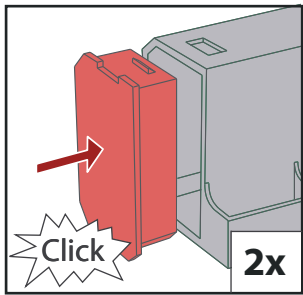

NA

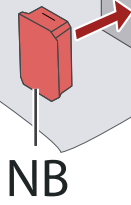

NB

3

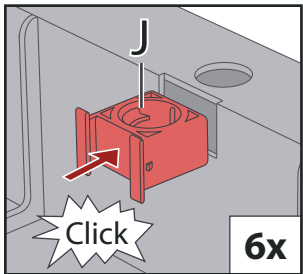

Click

6x

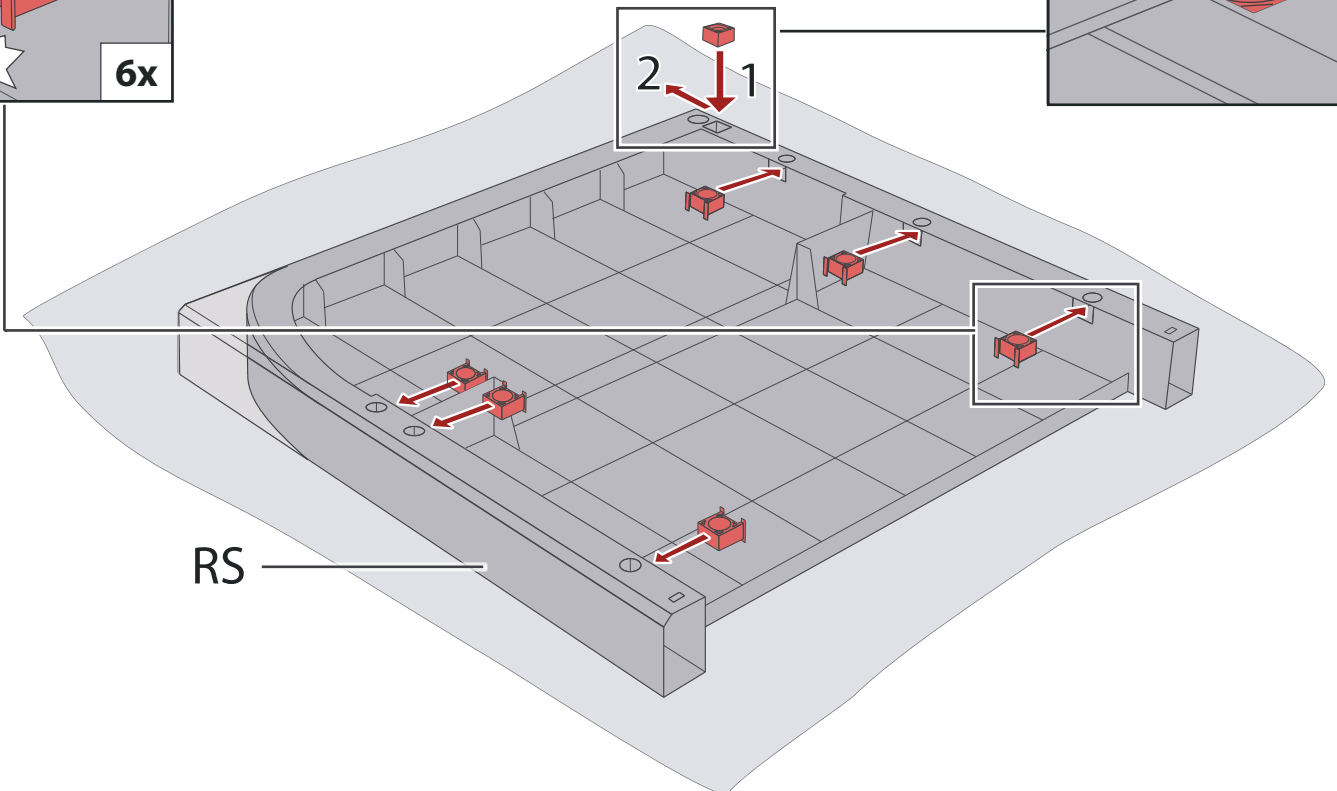

RS

4

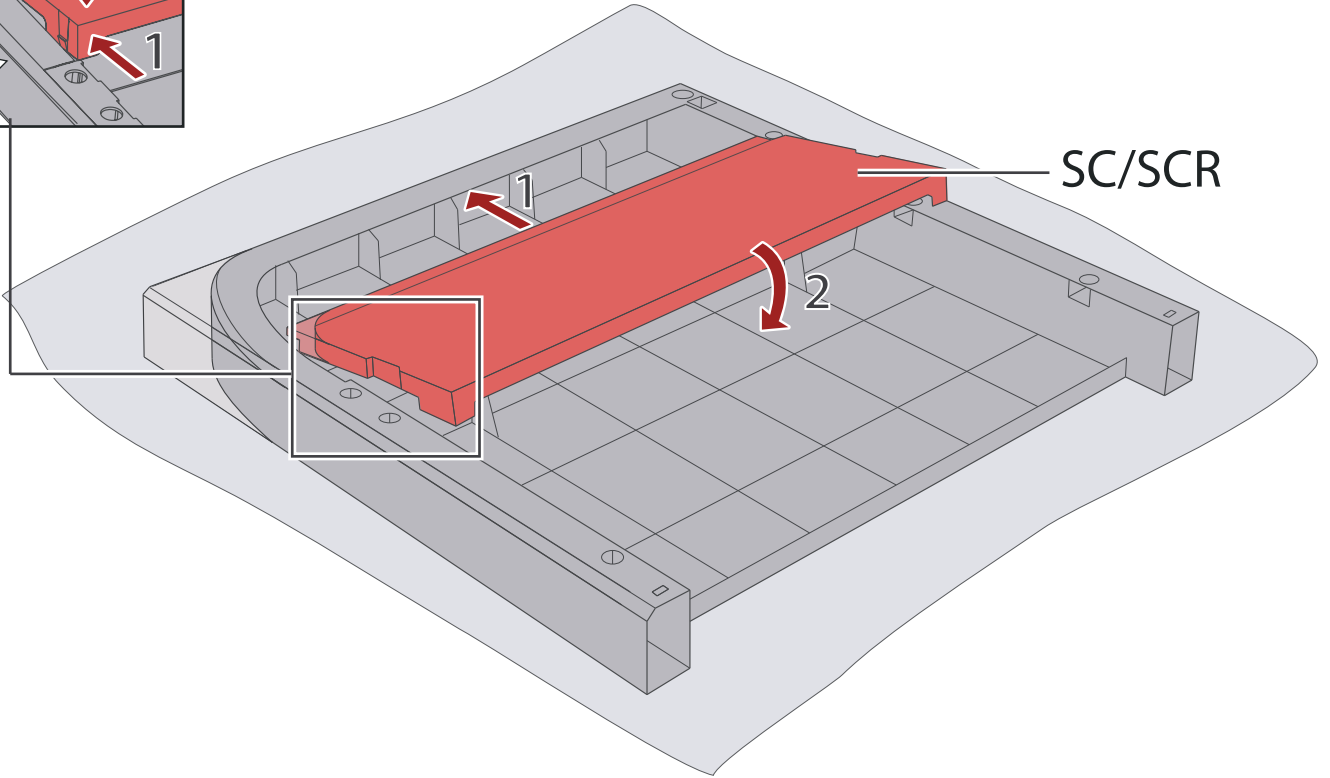
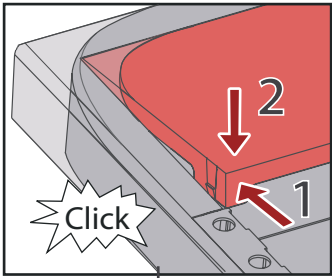

5

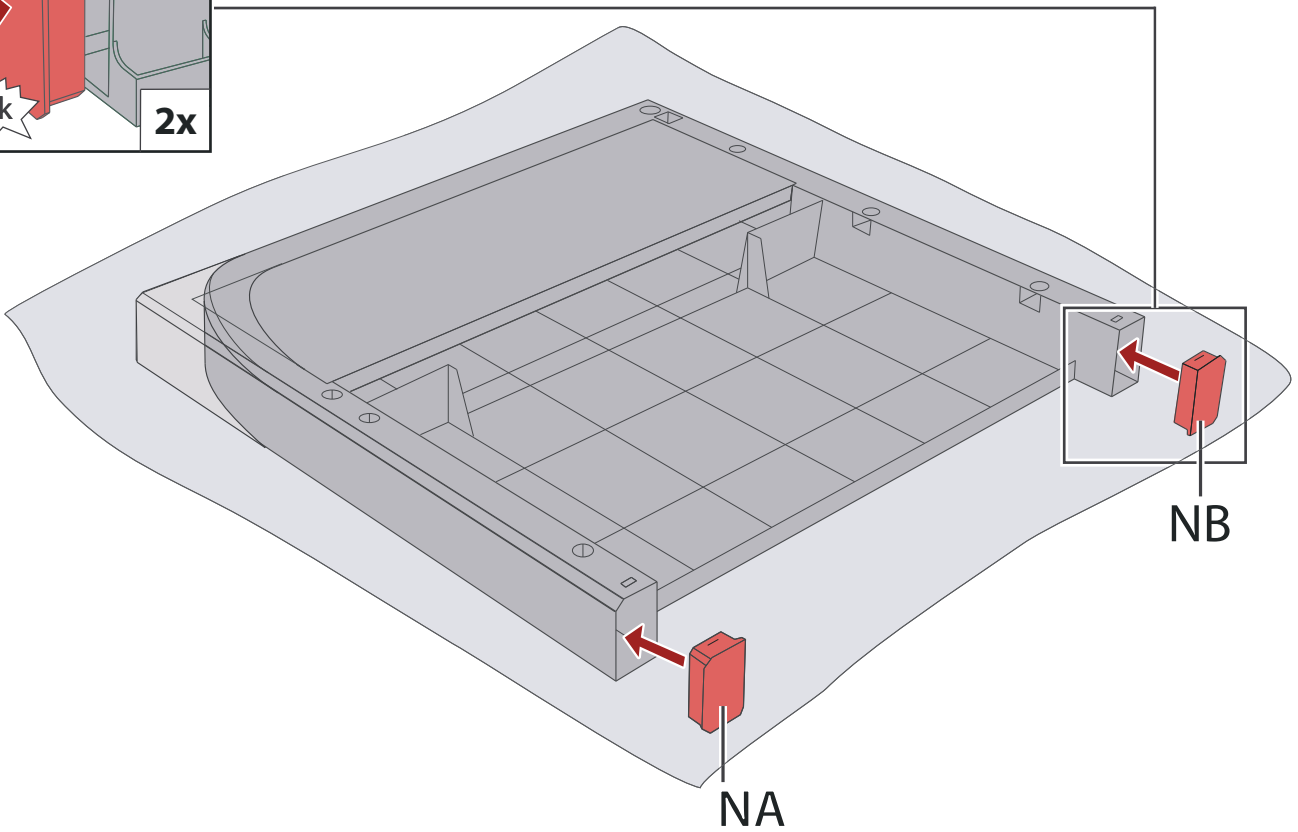
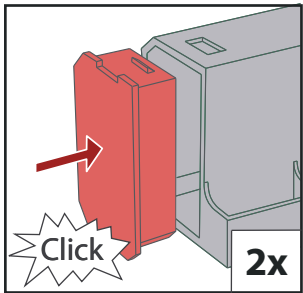

6

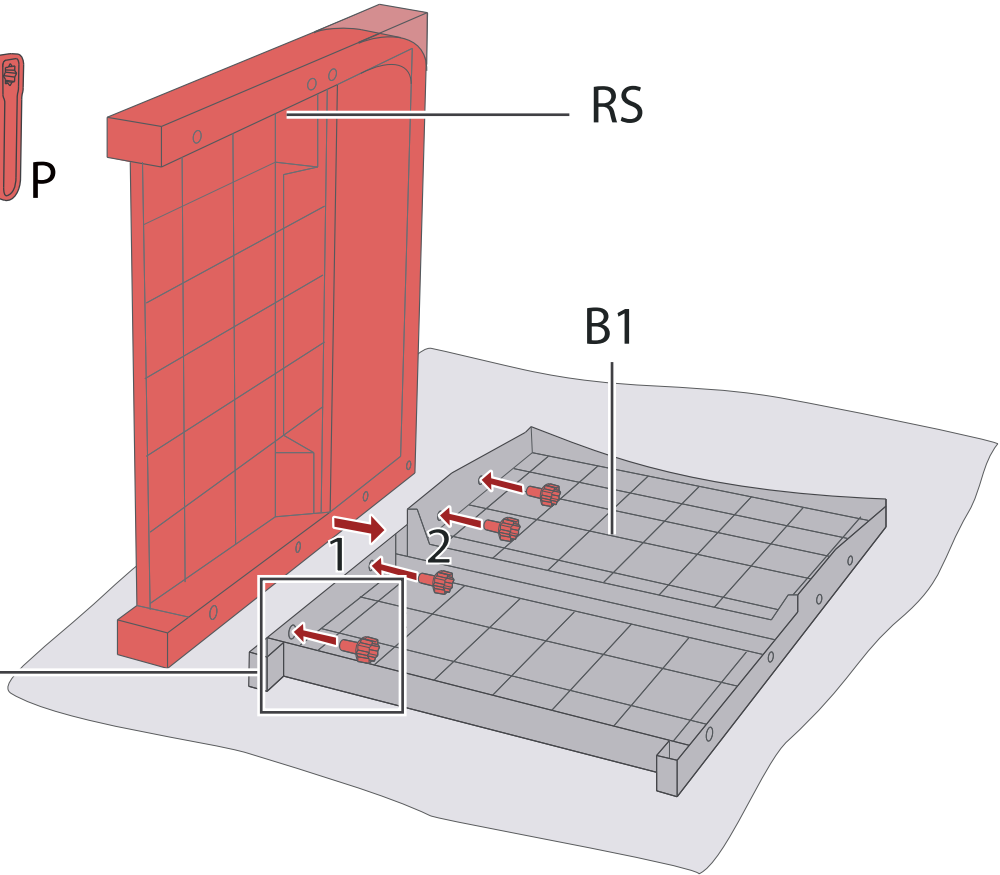
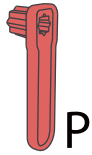
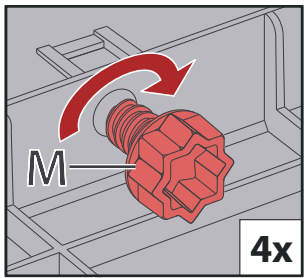

7

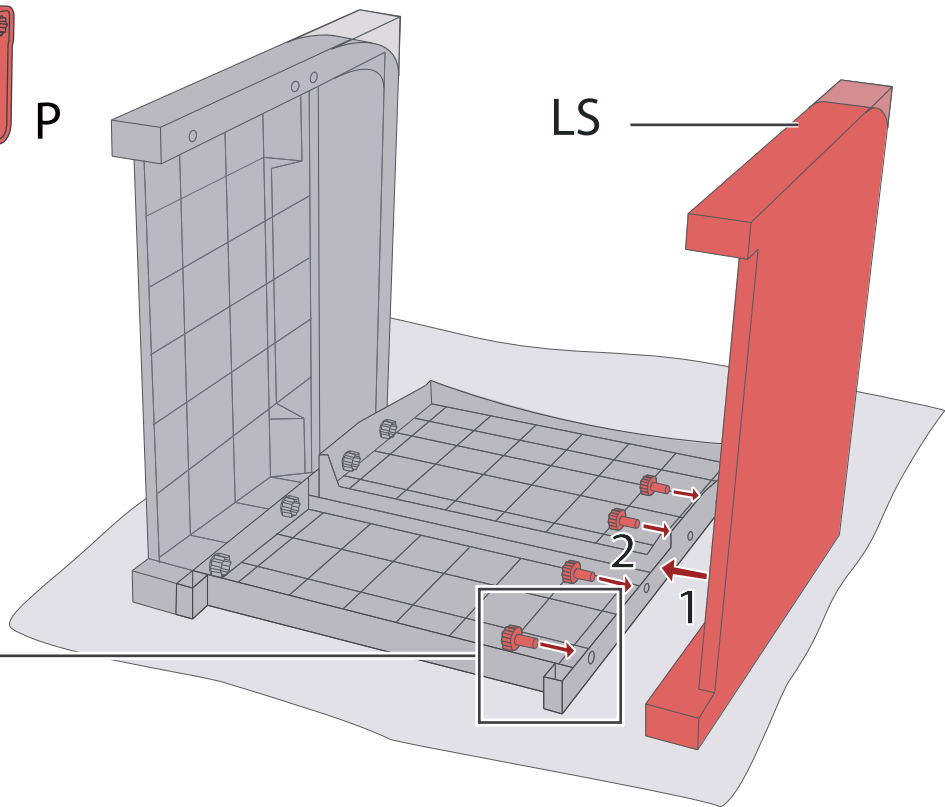
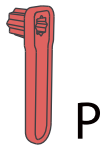
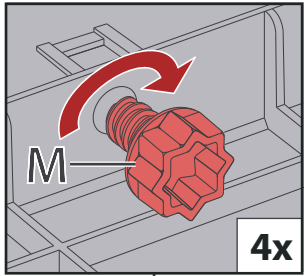

8

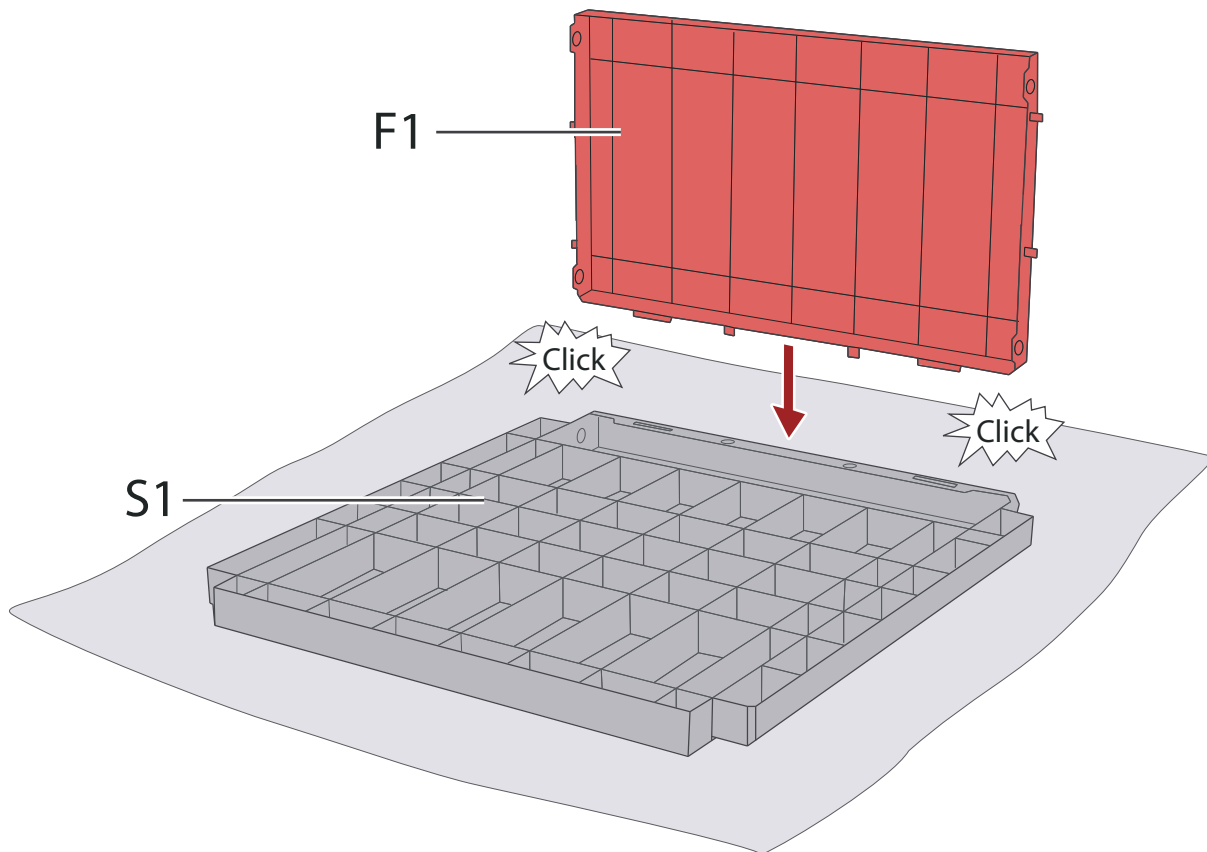

9

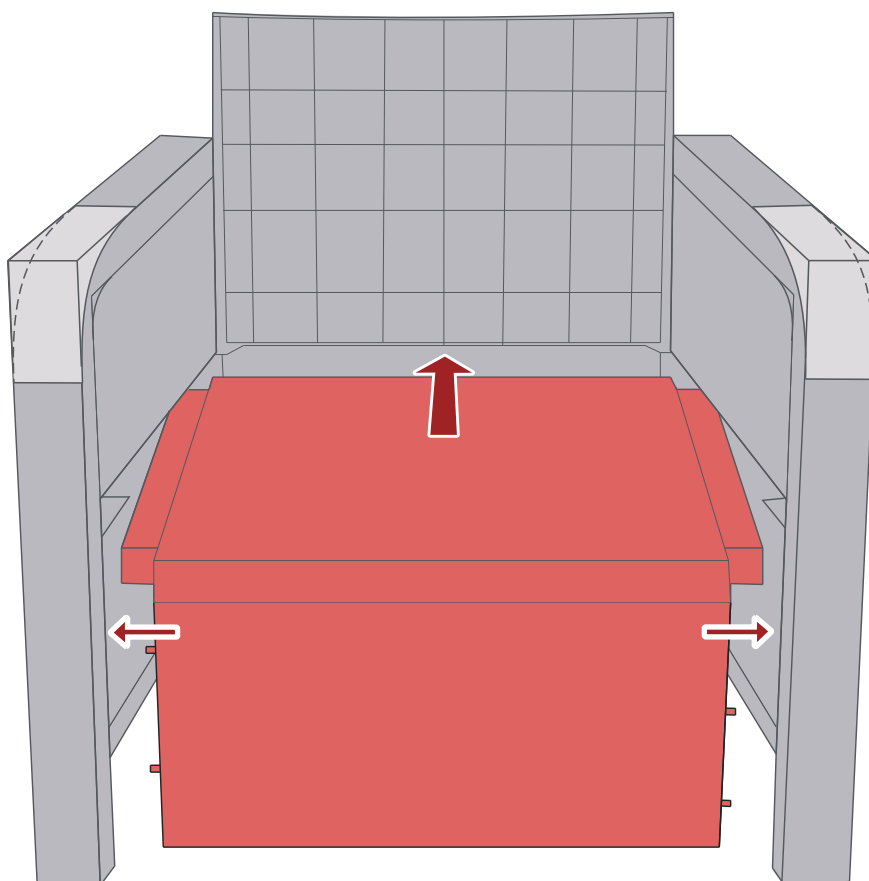

10

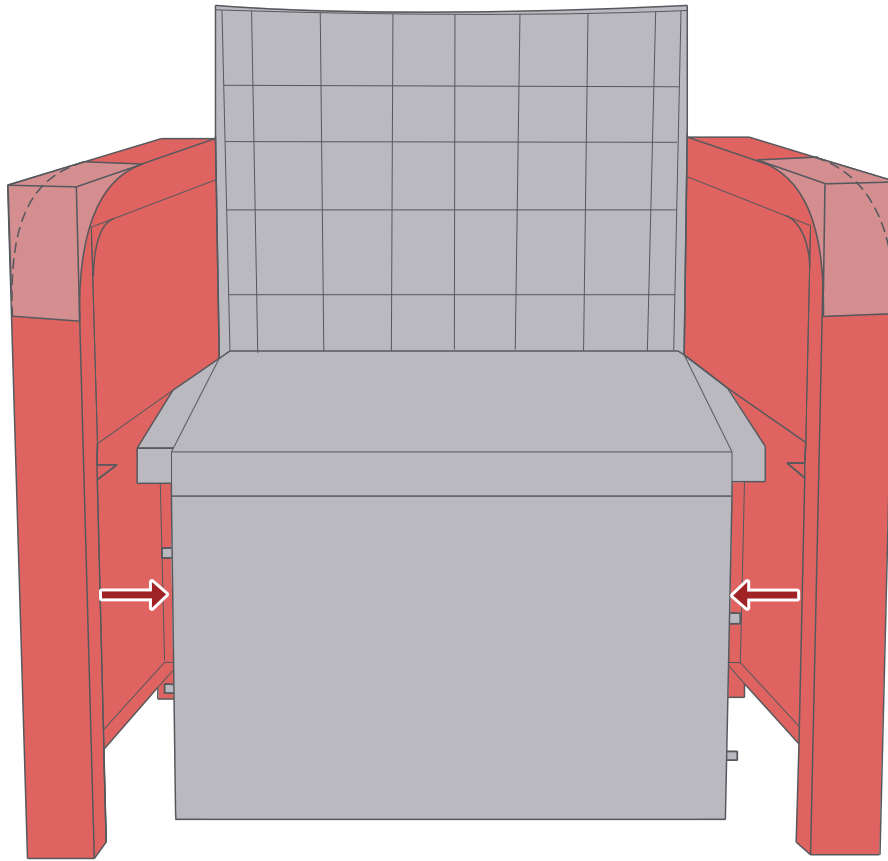

11

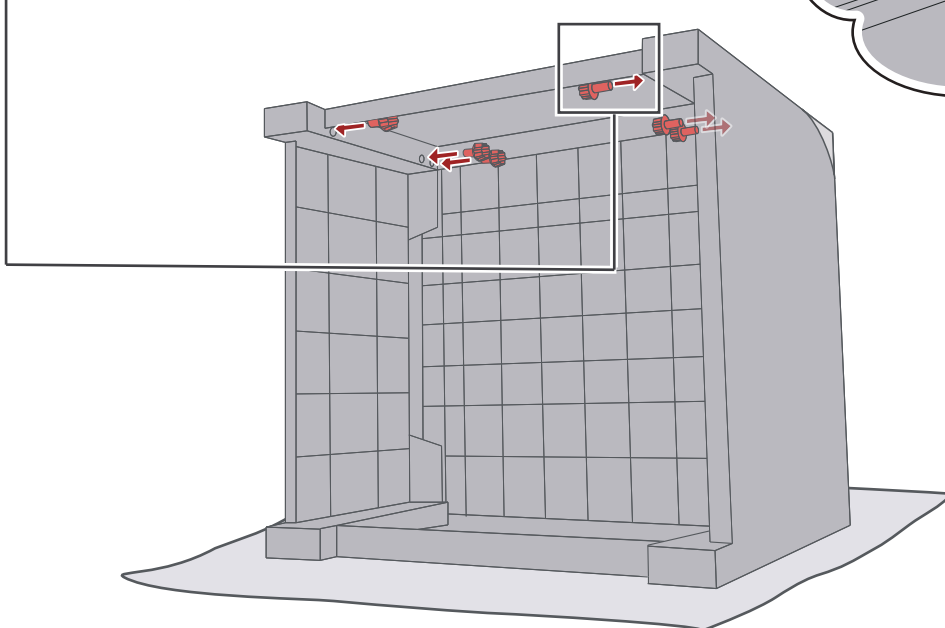
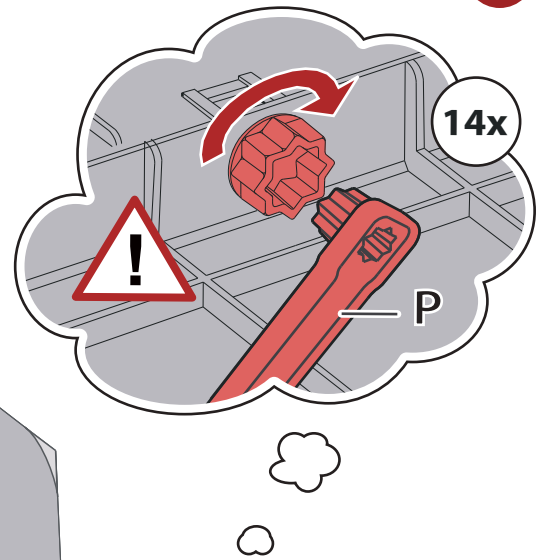
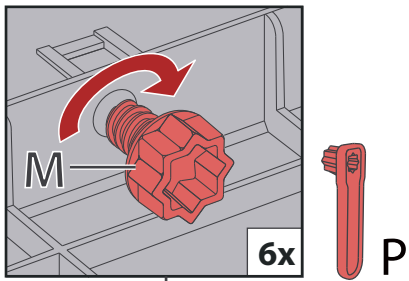

12



